

MATHARU grain dryers are advanced, portable dryer. These are easy to install anywhere without any civil work foundation. The performance is refined, accurate and pocket friendly.

These are meant to dry small and medium production with faster output.

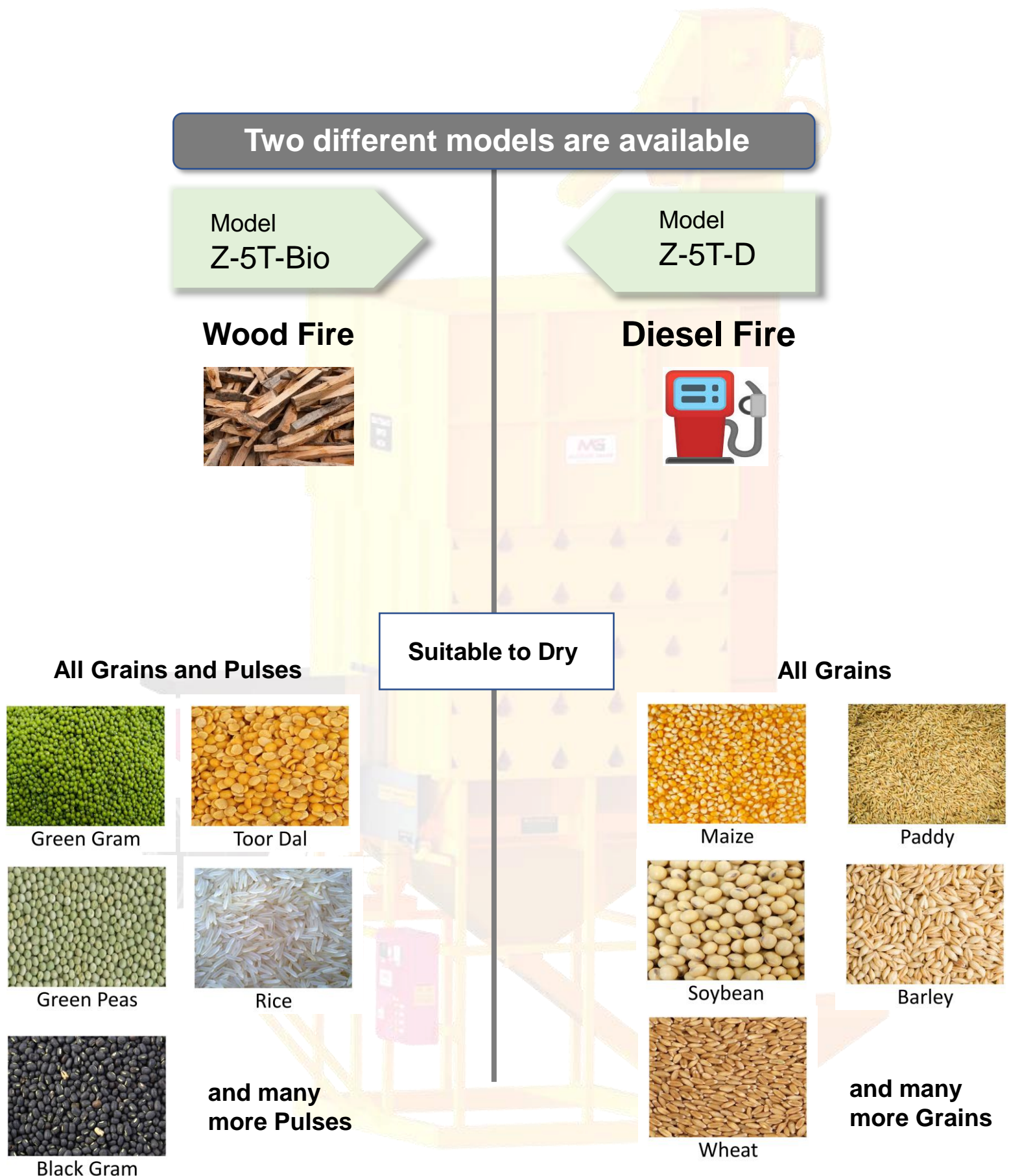

Machine  
Design  
Registered

Under IPR Act.  
Don't try to copy

Model  
Z-5T-Bio

Model  
Z-5T-D



Wood Fire



Diesel Fire

Model  
Z-5T-Bio



Model  
Z-5T-D



Dim. are in feet and Inch

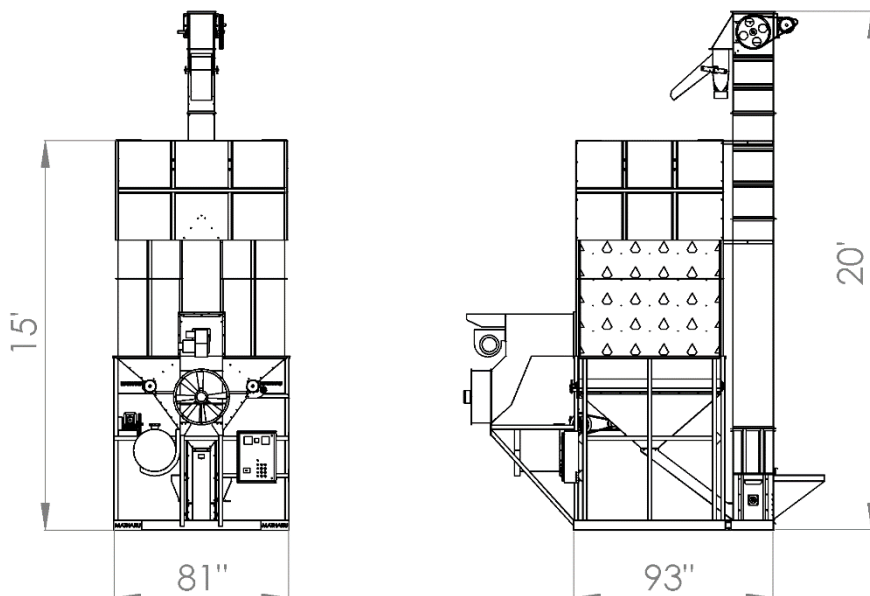
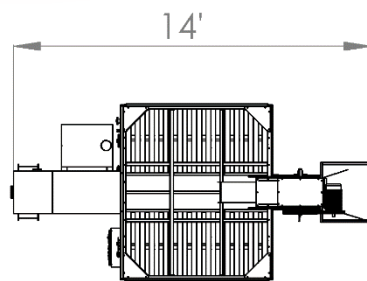

### Specifications

Type/Model	Z-5T-Bio	Z-5T-D
Batch capacity	5 ton (Maize)	
Tank Volume	7.0 m <sup>3</sup>	
Furnace fuel	Wood wate, 50 kg/hr*	Diesel, 13 ltr/hr*
Drying rate	1 - 3% per hr*	
Power Required	6 hp, 3 phase, 50hz ELECTRIC	
Loading and Recirculation	Bucket elevator	
Loading	In 60 min.*	
Unloading	In 60 min.*, By pulling a rope	
Temperature Display	Digital display, temperature depends on wood filling in the furnace	Digital display, temperature can be adjusted with controller.
Safety	Short circuit, over/under volt, high temperature cut	

### How it works

#### Loading

Grain filling in the Dryer.

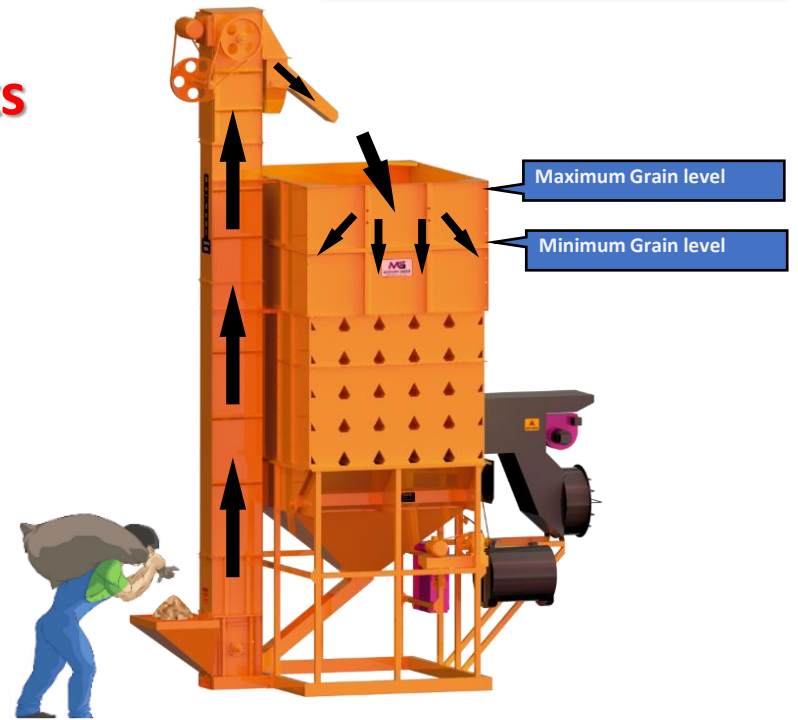

#### Circulation

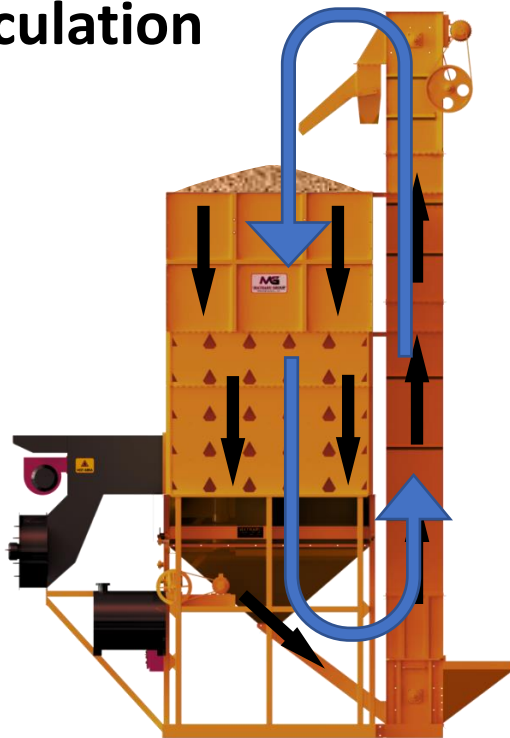

Grain circulating from down side  
To up side automatically.

#### Drying

The drying process continue till the grain  
dried up to required moisture %.

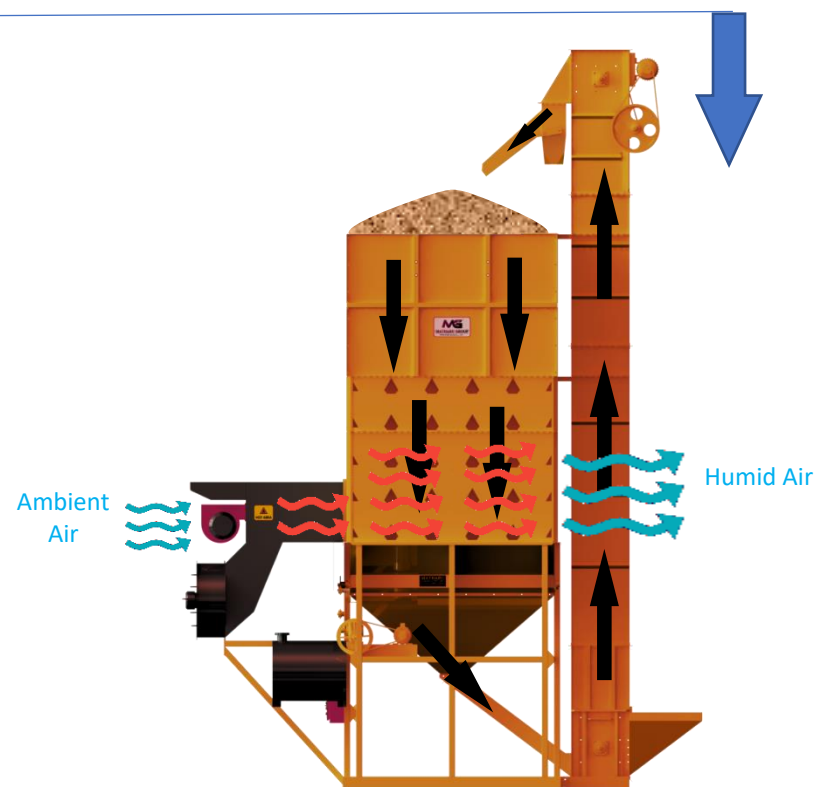

### Cooling

Heat source OFF but keep ON Air blower to cool down the grains for 20-30 minutes.

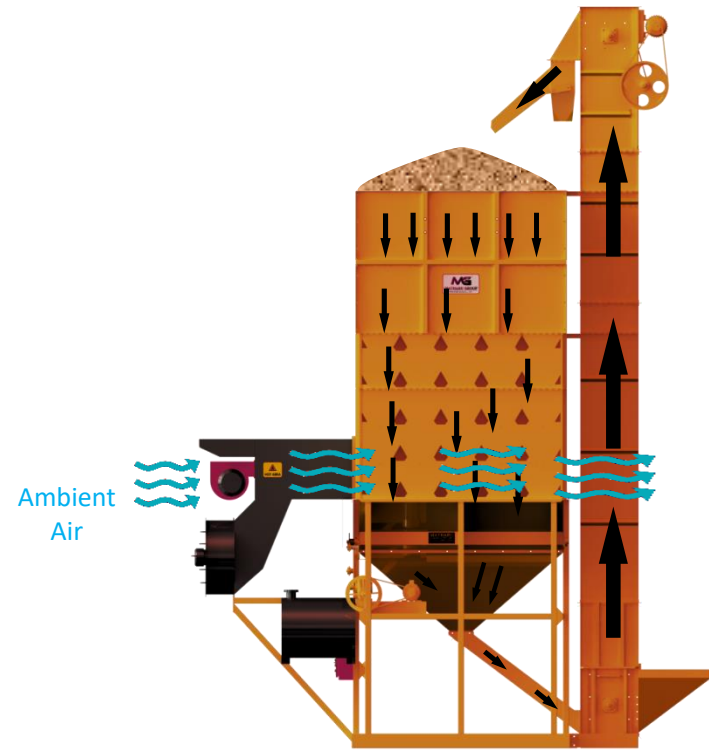

### Unloading

Pull the Discharge lever rope to put out all the grains from dryer through its discharge hopper.



Grain Drying  
Process Completed

# MATHARU

Grain Dryer Expert - INDIA

www.matharugroup.com

YouTube /matharugroup



ISO 9001 2015  
Certified



High Quality  
Manufacturing



Dedicated &  
Experienced



Comprehensive Parts  
and Service Backup



User friendly  
designs

MATHARU is an ISO 9001 : 2015 and NSIC – CRISIL rated company having all the facilities in house from R&D to production of each components. All the models of dryers are self designed and developed by the MATHARU and are “Designs registered” under IPR act in INDIA.



Manufactured by:

**Matharu Industries Pvt. Ltd.**

Ferozepur Road, Faridkot -151203 Punjab - INDIA

Mob: +91 93577 50577, 93577 50574

Tel/Fax: +91 1639- 250377, 256177

email: [info@matharugroup.com](mailto:info@matharugroup.com)

[www.matharugroup.com](http://www.matharugroup.com)